

# InTUBON LED DC 2.0



## Vorteile

- hohe Schlagfestigkeit IK10
- Hohe Lichtausbeute bis 160lm/W
- Schnelle und einfache Montage
- Markenkomponenten

18-32VDC

IP69K

IK10



## InTUBON LED DC 2.0 1

Barcode	P	lm	K	Ra	IP	Beam	KG
ITB2DC.10.017.8A4000	17	2950	4000K	>80	IP69K	90°X90° 60°X60°	1,8kg
ITB2DC.10.017.8A5000	17	3050	5000K	>80	IP69K	90°X90° 60°X60°	1,8kg

## InTUBON LED DC 2.0 2

Barcode	P	lm	K	Ra	IP	Beam	KG
ITB2DC.20.025.8A4000	25	4350	4000K	>80	IP69K	90°X90° 60°X60°	2,2kg
ITB2DC.20.025.8A5000	25	4450	5000K	>80	IP69K	90°X90° 60°X60°	2,2kg

## InTUBON LED DC 2.0 3

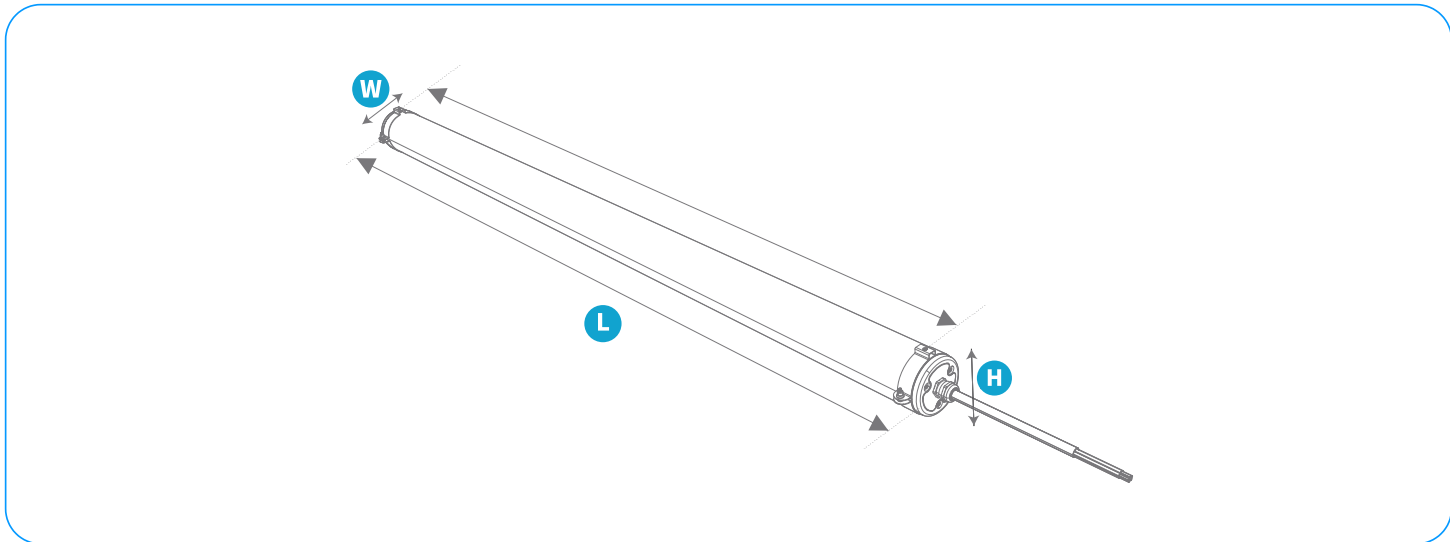

Barcode	P	lm	K	Ra	IP	Beam	KG
ITB2DC.30.033.8A4000	33	5800	4000K	>80	IP69K	90°X90° 60°X60°	2,6kg
ITB2DC.30.033.8A5000	33	5900	5000K	>80	IP69K	90°X90° 60°X60°	2,6kg





	H	W	L
ITB2DC.1	70	70	720
ITB2DC.2	70	70	1000
ITB2DC.3	70	70	1280

## Montageart





Deckenaufbau

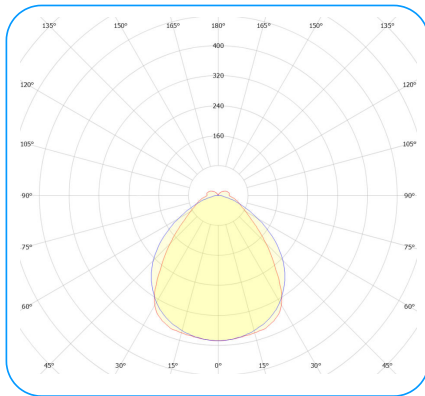

Seilabhängung

## Lichtstrom

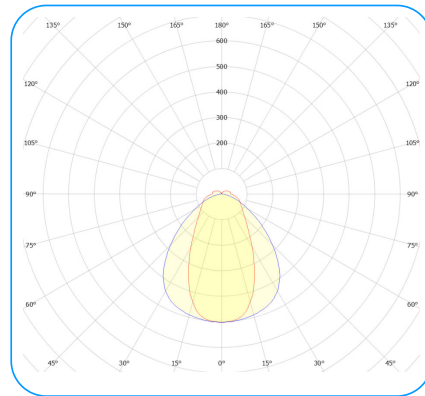

90°X90°



60°X60°

## Verfügbare Konfigurationen

Familie	Leistungsvarianten	Version	Nennleistung [W]	CRI	Typ der Diode	CCT [K]	Material der Linse	Material des Diffusors	Abstrahlwinkel	Lichtsteuerung	Betriebstemperatur [°C]	Garantie	Modifikationen
ITB2DC InTUBON LED DC 2.0	1 1	0 Standard	017 17W	8 >80	A Mid Power	4000 4000K	2 PC Linse	P21 PC Diffusor Transparent	060060 60°x60°	00 On/Off	2540 -25°C:+40°C	03Y 3 Jahres	0000 Keine
	2 2		025 25W			5000 5000K			090090 90°x90°				
	3 3		033 33W										

## Beispiel-Produktcode

ITB2DC.10.017.8A4000.2P21.090090.00.2540.03Y.0000

## Fotogalerie

